

RTL8208B

RTL8208B (128Pin SOCKET)

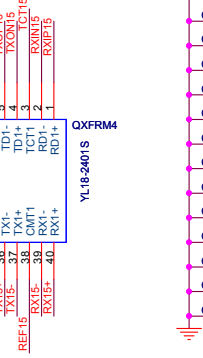

Layout Note: Close to RTL8208B

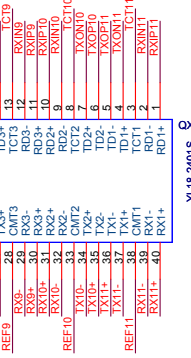
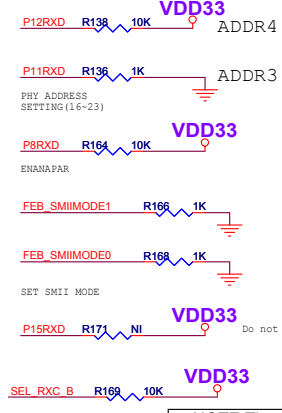
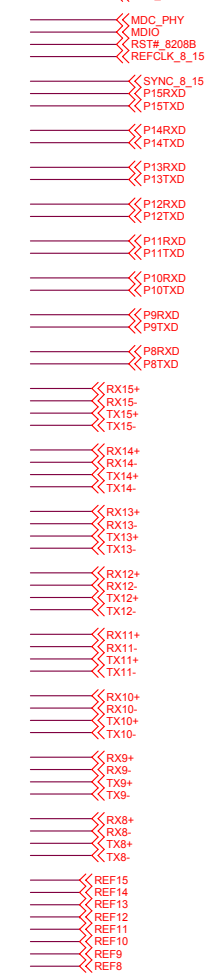
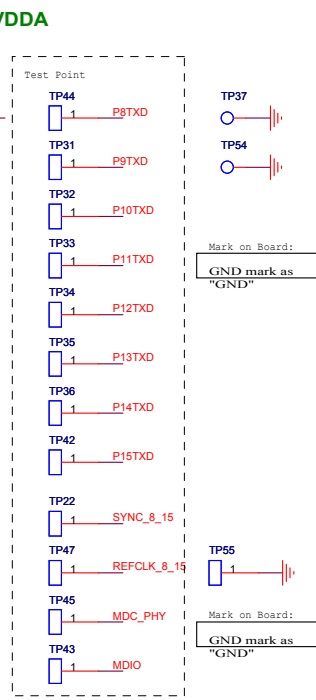
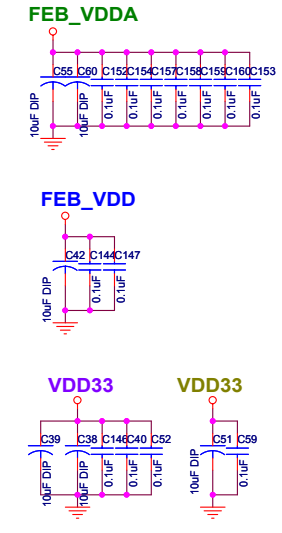
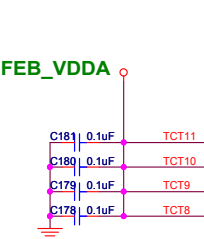
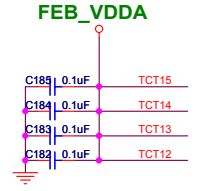
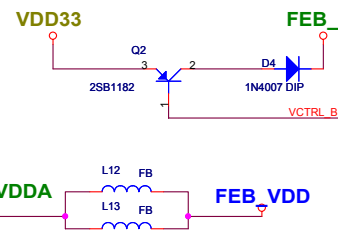

NOTE: The contact windows of buying the transformer YL18-2401S is listed as below:
 YuTai Electronics Co.,LTD
 TEL:86-574-63620701,63621610
 EMAIL: nico_yu@yeah.net
 www.yutai-elec.com

Mark on Board:
GND mark as "GND"

Mark on Board:
GND mark as "GND"

Do not install R171